



MKT V-4E_{SC}

INSTALLATION GUIDE

Please read through the instructions thoroughly before performing any of the steps.

MKT V-4Esc OPERATING, MAINTENANCE AND SERVICE MANUAL



Prior to the use of this equipment everyone that will be or will assist in the operation of this equipment must read and understand the MKT V-4Esc Operating, Maintenance and Service Manual. Failure to read and understand the MKT V-4Esc Operating, Maintenance and Service Manual will result in property damage, severe injury or death.

SAFETY INSTRUCTIONS

The following signal words will be found in this guide and may also be found in the MKT V-4Esc Operation, Maintenance and Service Manual. These words are intended to alert the operator(s) to a hazard and the degree of severity of the hazard.



Indicates a hazardous situation which, if not avoided, will result in death or serious injury.



Indicates a hazardous situation which, if not avoided, could result in serious injury.



Indicates a hazardous situation which, if not avoided, could result in minor injury or moderate injury.



Indicates a property damage message.

EXCAVATOR STICK PREPARATION

The bucket will need to be removed prior to vibratory hammer installation.

Maximum Stick Width 16.5 inches

Minimum Pin Diameter 80mm

Maximum Pin Diameter 100mm



HAMMER TO STICK ALIGNMENT

Place hammer with the manifold on the right of the stick facing the machine.



The stick pin will go to the top and the H-link pin will go to the bottom



ADD SPACERS TO THE PINS AS
NEEDED

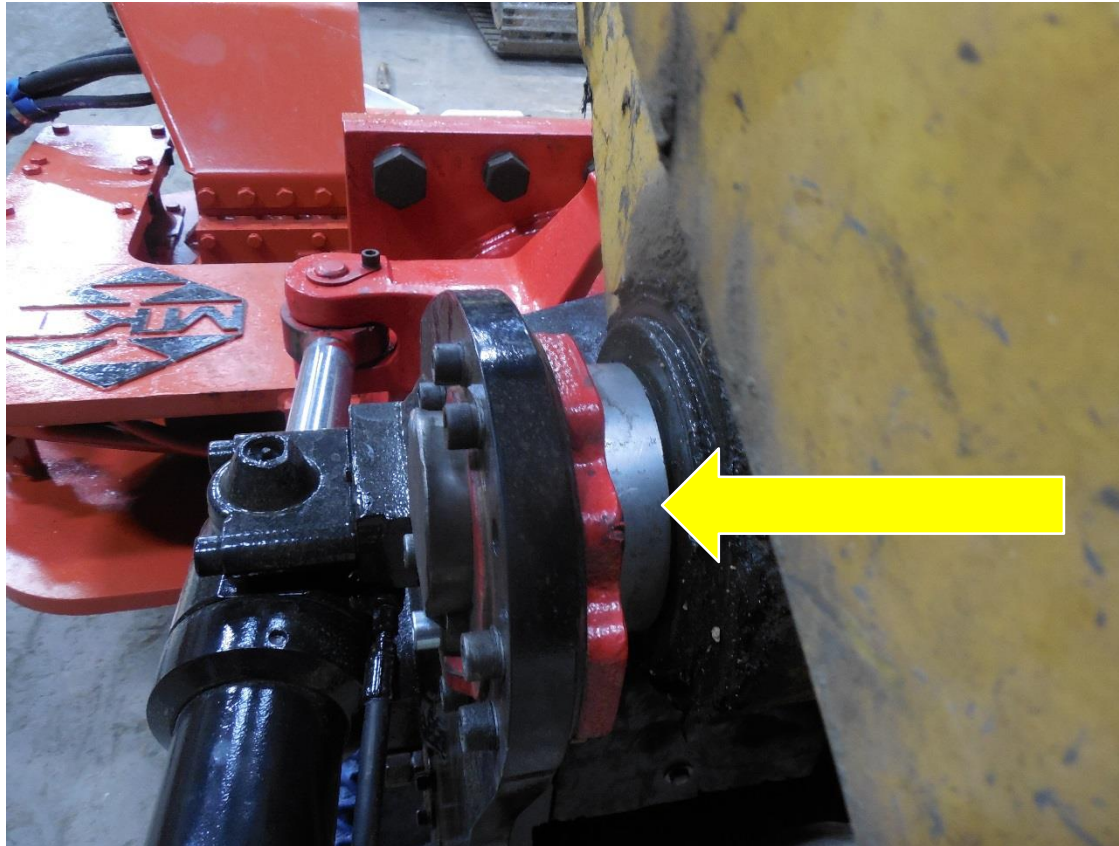

PLACE ELECTRICAL STAND ON THE EXCAVATOR

The electrical stand comes with magnetic feet. You will need to place the stand on a flat metal surface.



RUN THE ELECTRICAL CORD DOWN THE BOOM

The only cord that goes down the boom is the Boom cable with the Ten pin connector



POWER SUPPLY

Red cable is for 24v supply. White is positive, black is negative and needs to be connected to a 24v power supply



AUXILIARY CONTROL CIRCUIT

The Blue cable is to be used to control the auxiliary circuit on the excavator. Due to the wide range of excavator controls, please contact your local excavator dealer for your brand of excavator. This is a 24v signal and white is positive and black is negative. If your system is negatively switched, you will need a relay in-line for our auxiliary control to control your system. Please refer to the next slide for an example of this connection.

NOTICE

If you have any questions please contact your local MKT representative.

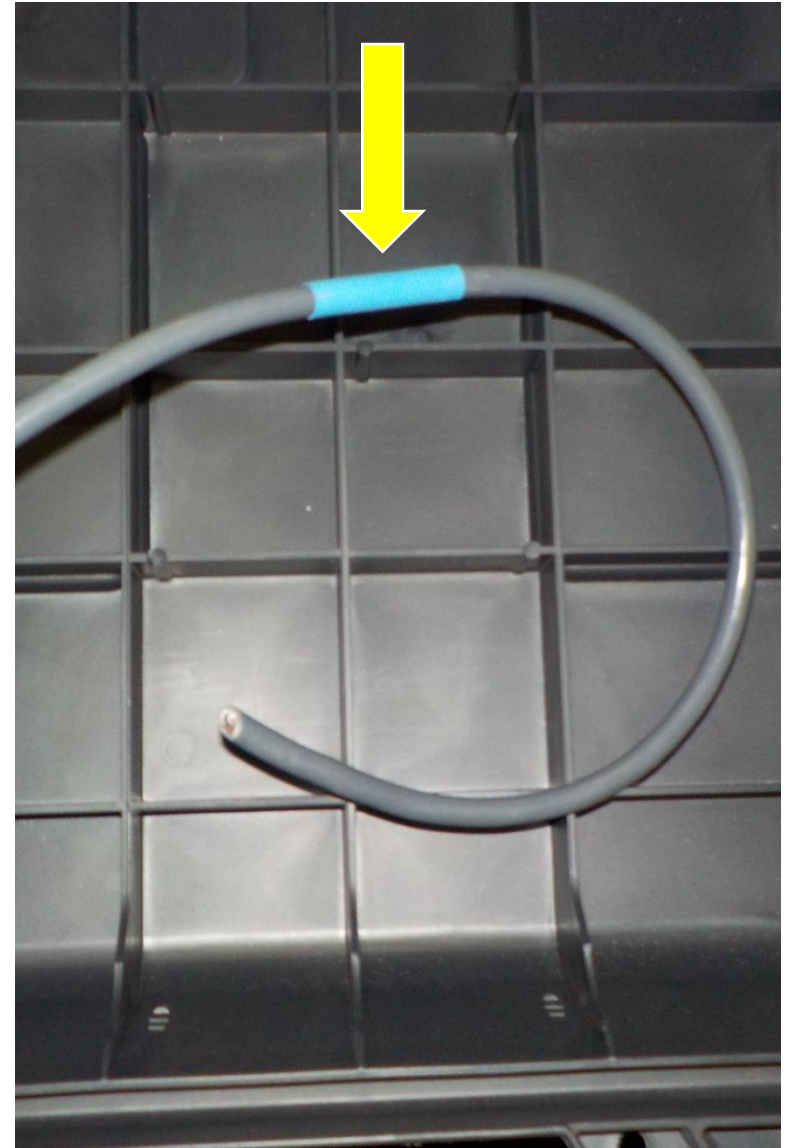

THIS IS AN EXAMPLE OF HOW TO PUT A RELAY IN LINE TO CONTROL A NEGATIVELY SWITCHED CIRCUIT ON A CATERPILLAR 336F

The Blue Auxiliary control cord from the MKT junction box is connected to the relay with black wire to the negative terminal #85 and the white wire to the positive terminal #86

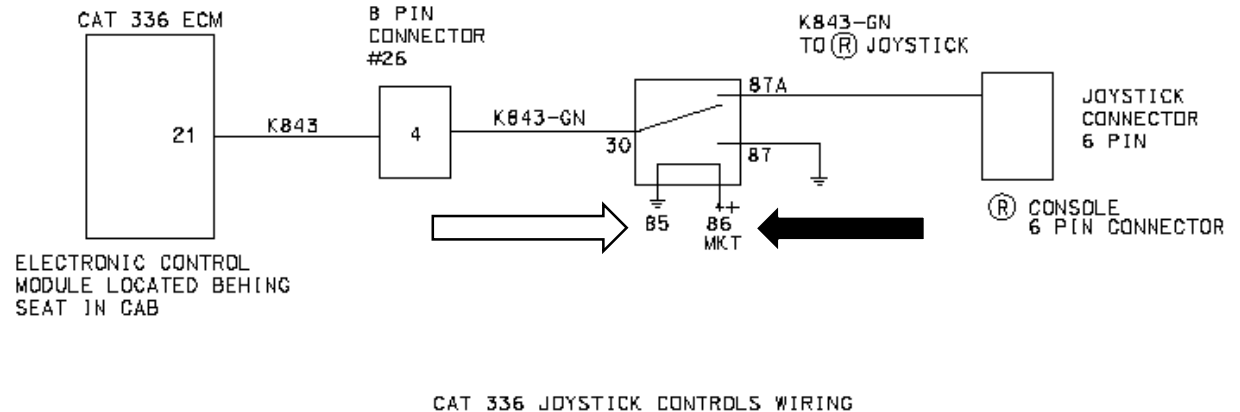

ROTOTILT BOOM CABLE

10 Pin Boom Cable



Connect Boom Cable to Rototilt Spider Cable

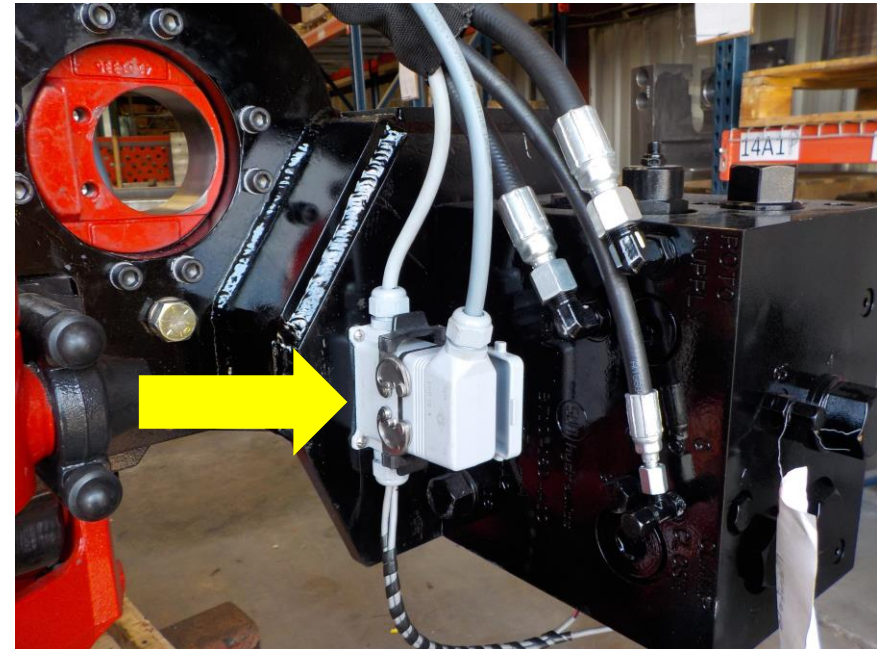

#11/12 AND #13 SOLENOIDS

The two solenoids #11/12 and #13 Stay connected at all times

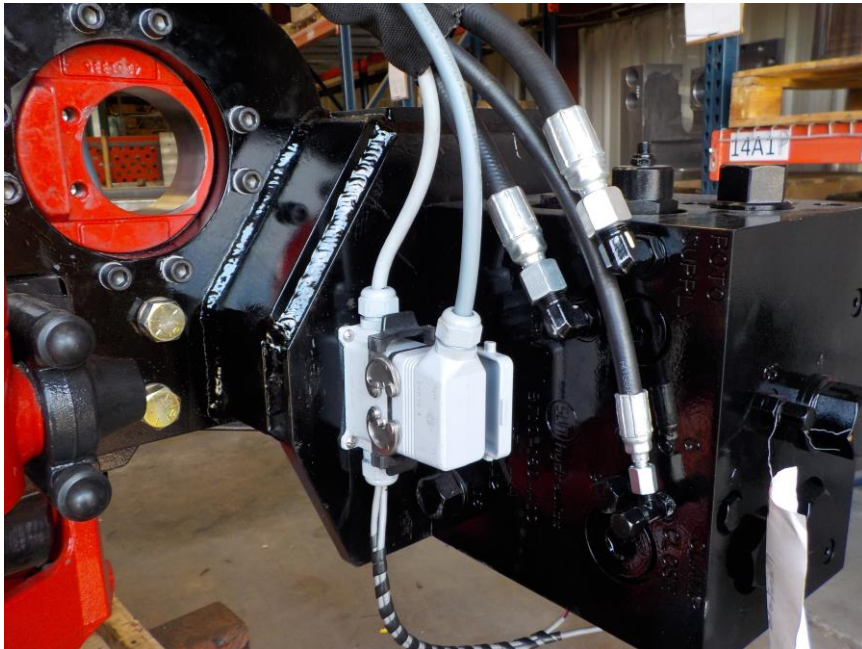

These are Deutsch plugs

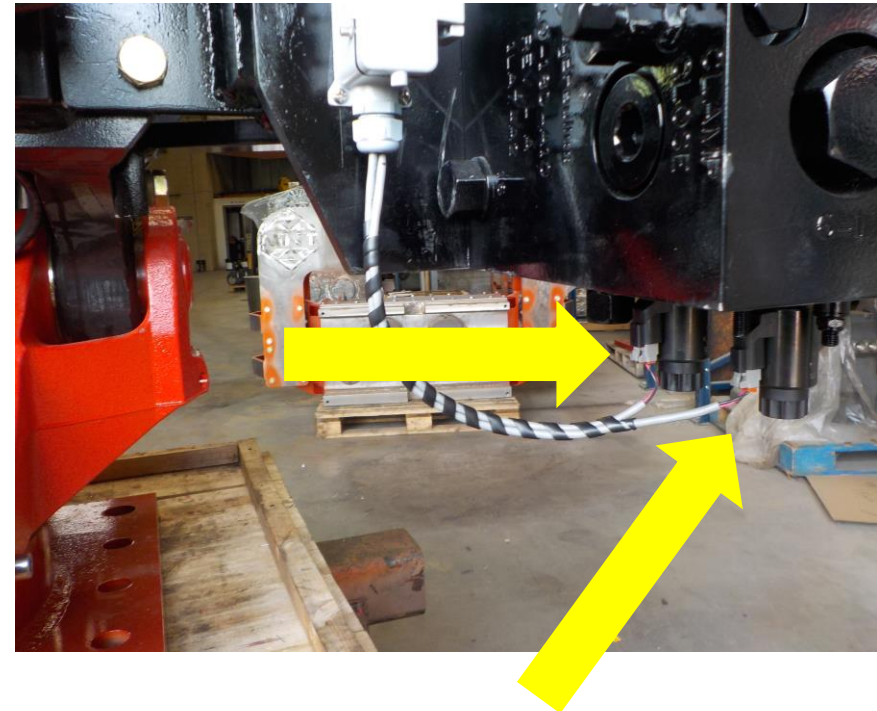

EXCAVATOR FLOW AND PRESSURE CHECK

- Before connecting to the MKT manifold you will need to activate the auxiliary circuit to verify the hydraulic flow path. A flowmeter works best for this. The MKT V-4Esc requires a flow of 45 gallons per minute with no back pressure. The auxiliary circuit needs a minimum pressure of 4500 psi.
- **NOTICE** Reversing the auxiliary circuit or applying flow to the manifold RETURN port will cause damage to the manifold's internal components.

HYDRAULIC CONNECTIONS

Once the direction of flow on the auxiliary circuit has been verified you can proceed with making the hydraulic connections as follows.

- Connect the Auxiliary supply circuit to the SUPPLY port on the manifold valve using a hose that is rated for the Excavators Maximum pressure capability.
- Connect the Auxiliary return circuit to the RETURN port on the manifold valve using a hose that is rated for the Excavators Maximum pressure capability.



CASE DRAIN LINE

Connect a 3/4 inch drain line with a hydraulic hose rated for 100R12 or greater to the DRAIN port on the manifold valve. Route the hose back up the boom to the reservoir.

- **NOTICE** We need minimal restriction back to the hydraulic reservoir .

- **NOTICE** Failure to connect the Drain line to the hydraulic reservoir will cause damage to the internal components of the manifold and cause the vibratory motor to have a seal failure.



MKT V-4Esc OPERATING, MAINTENANCE AND SERVICE MANUAL



Prior to the use of this equipment everyone that will be or will assist in the operation of this equipment must read and understand the MKT V-4Esc Operating, Maintenance and Service Manual. Failure to read and understand the MKT V-4Esc Operating, Maintenance and Service Manual will result in property damage, severe injury or death.

⚠ DANGER CLEAR THE AREA

Verify all personnel are clear of the vibratory hammer before proceeding to the next step.

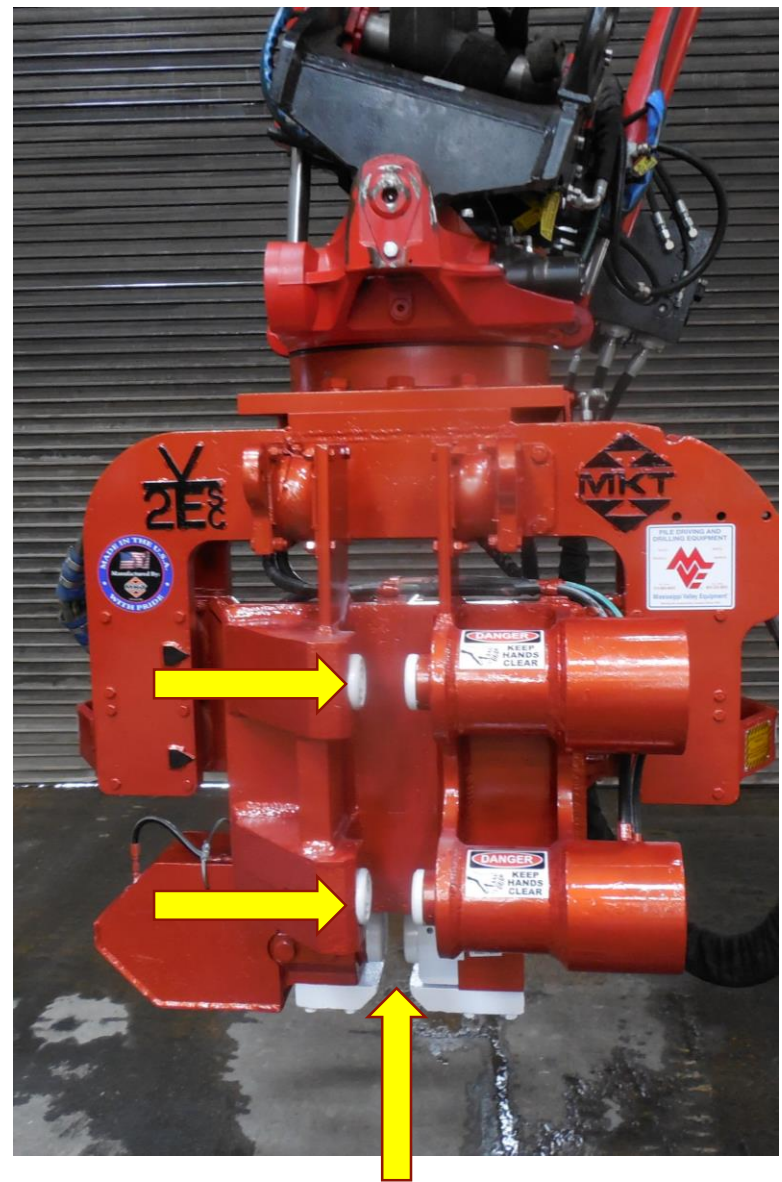

POWERING UP THE CONTROLS

With the excavator running turn the power switch on the junction box to the ON position.

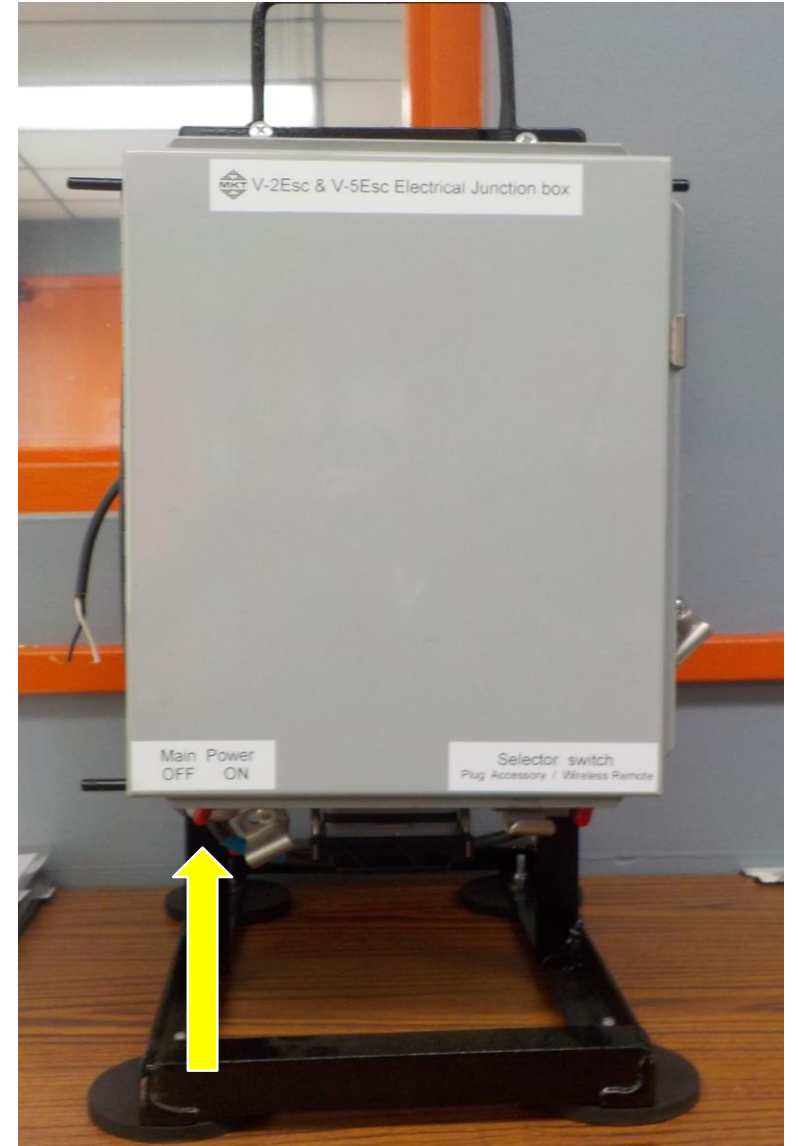

POWERING UP THE REMOTE

Once you have the junction box powered up you can push the on button (Green) to the remote.

The power to the junction box has to be turned on before you can turn on the remote. *If you turn the remote on first the system will not recognize the remote.*

Both the transmitter and the receiver will “time out” after 30 minutes of inactivity. *If this happens you will need to go through the power up sequence again.*

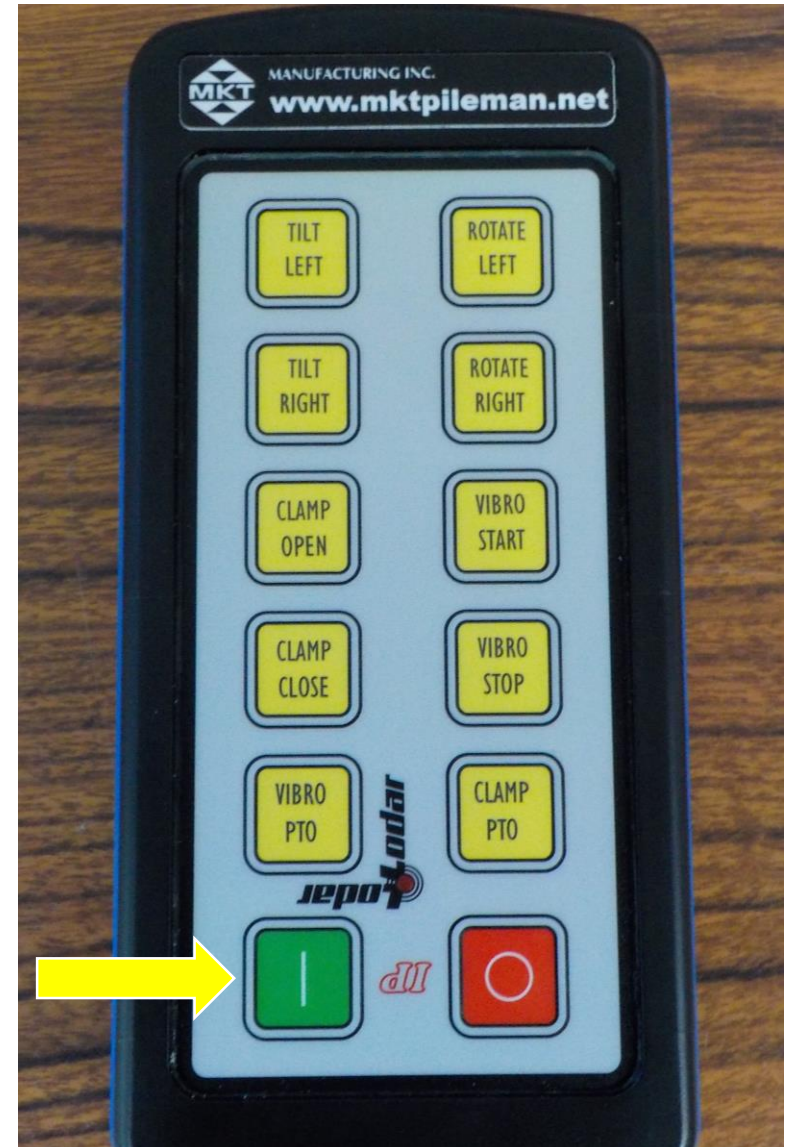

OPERATION OF UNIT

Once you have followed the proper power up process you are now ready to start controlling the unit.

TILT function is controlled by pushing the top button to tilt left and the bottom button to tilt right.

Rotate function is controlled by pushing the top button to rotate left and the bottom button to rotate right.

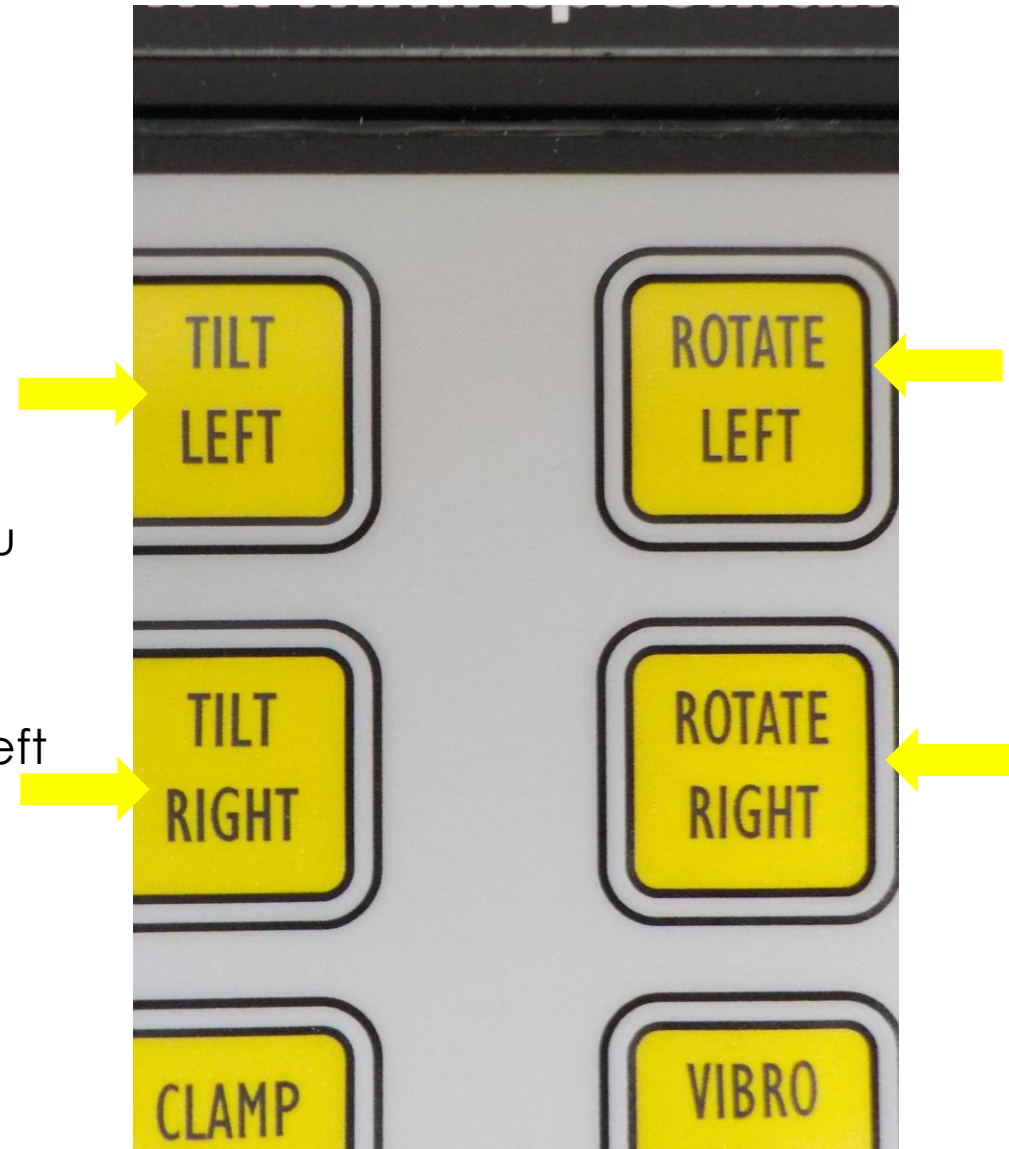

OPERATION OF UNIT

Clamp function is controlled by first holding the Clamp PTO button down that is located to the bottom right of the clamp function switches.

Once you have the PTO switch held down you can now operate the clamp by pushing the clamp open function to open the clamps and the clamp close function button to close the clamp.

The Clamp PTO has to be held down to use either clamp button.

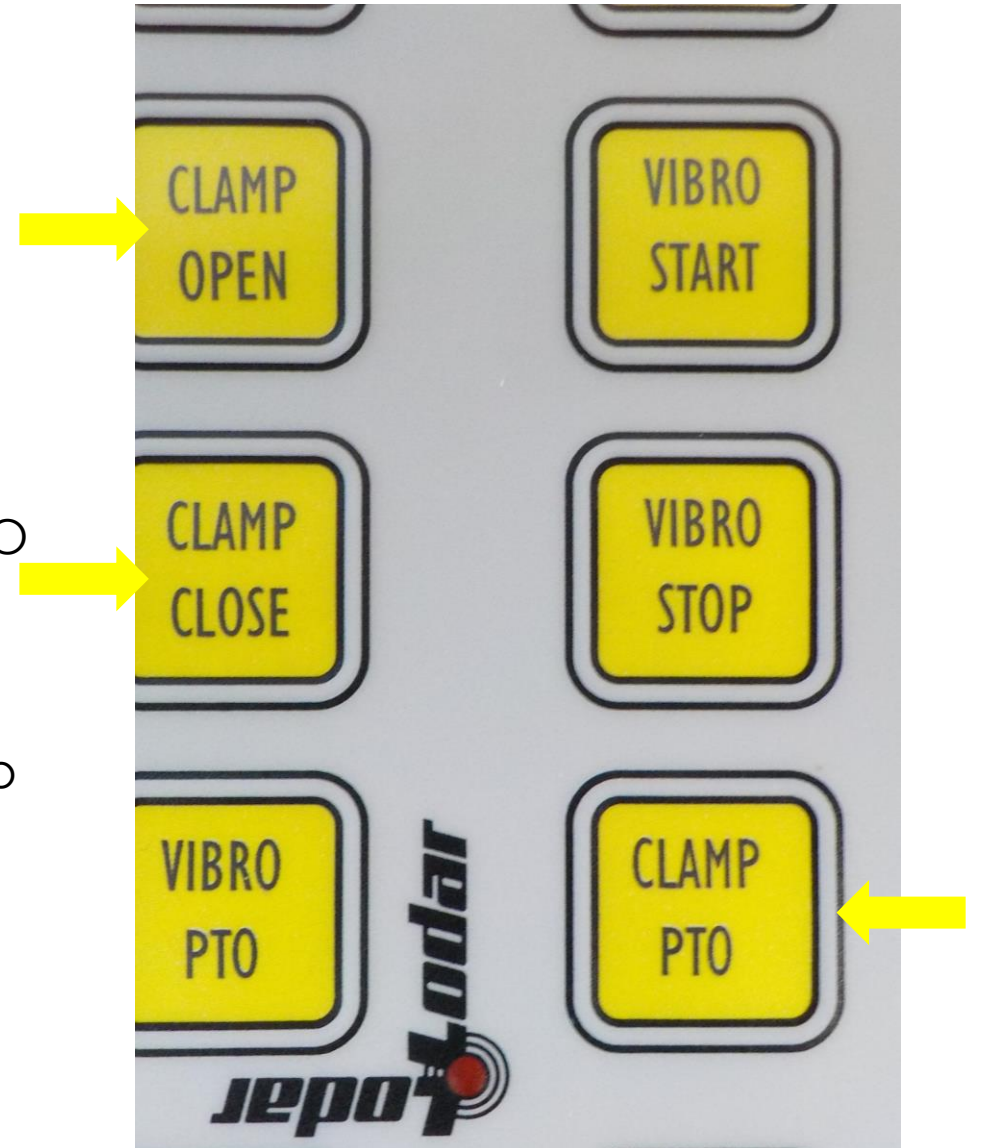

OPERATION OF UNIT

The vibratory function is controlled by first holding the Vibro PTO button down that is located to the bottom left of the vibro function switches.

While you have the Vibro PTO held down you will need to push the Vibro Start switch to Start the vibration of the hammer. The vibratory will continue to vibrate with out holding the buttons until you push the Vibro Stop function button.

While turning the vibratory hammer off you will NOT need to push the PTO button

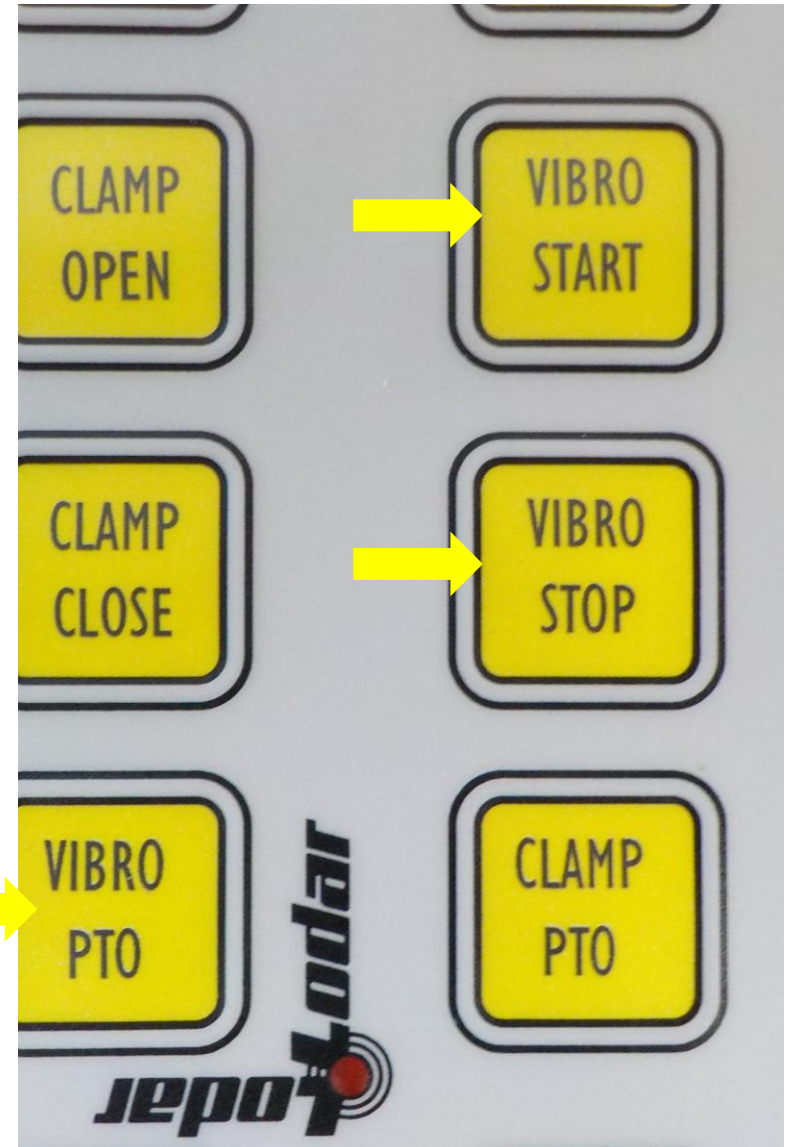

BLEEDING THE CLAMP CIRCUIT

NOTICE

When ever the hydraulic lines of the MKT V-4Esc system have been reconnected and or when hydraulic repairs have been made, the clamp cylinders must be bled of entrained air.

This procedure must be done with the hammer hanging vertical.

⚠ WARNING

Contents of hydraulic components may be under pressure extreme care should be taken when opening the components.

- Following the instructions in the previous slide to operate the clamp functions. Close the jaws and hold the clamp close function while you open the bleeder on the back of the bottom clamp . **Do not back vent screw all the way out!**
- Allow oil to vent approximately 30 seconds or until an air free stream of oil comes from each vent screw.



BLEEDING THE CLAMP CIRCUIT

NOTICE

When ever the hydraulic lines of the MKT V-4Esc system have been reconnected and or when hydraulic repairs have been made, the clamp cylinders must be bled of entrained air.

This procedure must be done with the hammer hanging vertical.

WARNING

Contents of hydraulic components may be under pressure extreme care should be taken when opening the components.

- Following the instructions in the previous slide to operate the clamp functions. Close the jaws and hold the clamp close function while you open the bleeder on the back of the bottom side clamp . **Do not back vent cap all the way out!**
- Allow oil to vent approximately 30 seconds or until an air free stream of oil comes from each vent screw.

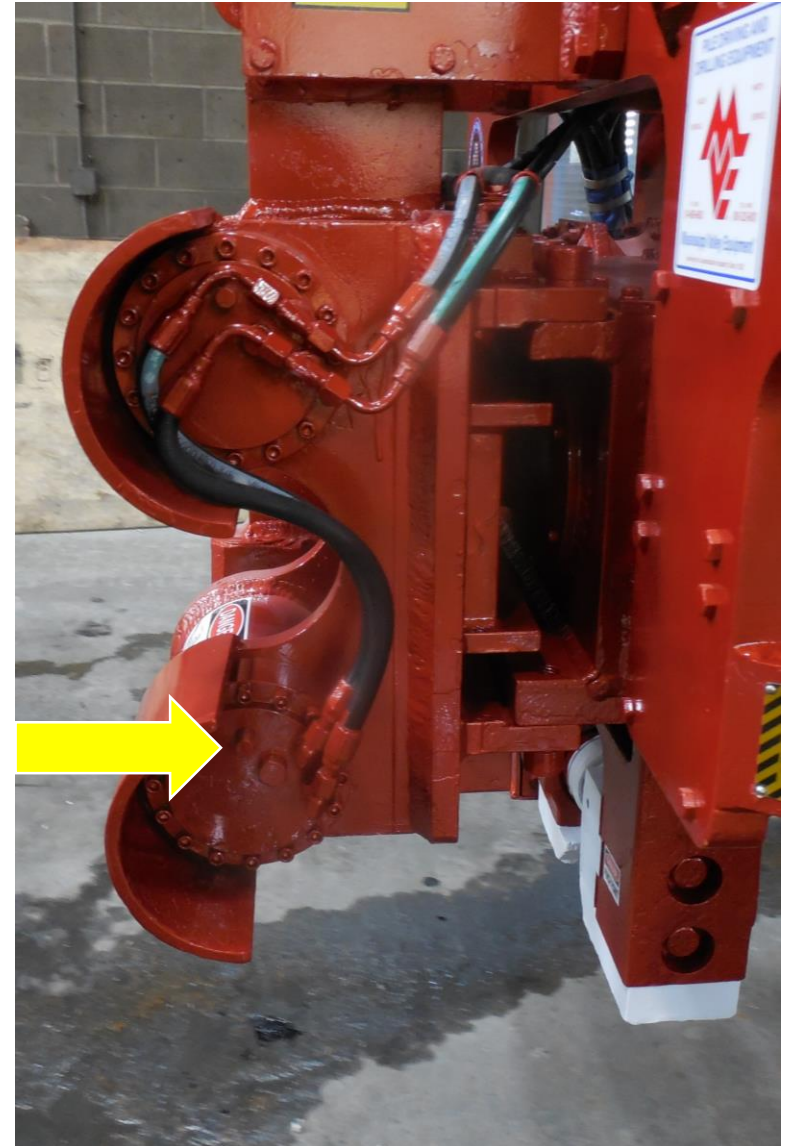

BLEEDING THE CLAMP CIRCUIT

NOTICE

When ever the hydraulic lines of the MKT V-4Esc system have been reconnected and or when hydraulic repairs have been made, the clamp cylinders must be bled of entrained air.

This procedure must be done with the hammer hanging vertical.

WARNING

Contents of hydraulic components may be under pressure extreme care should be taken when opening the components.

- Following the instructions in the previous slide to operate the clamp functions. Close the jaws and hold the clamp close function while you open the bleeder on the back of the top side clamp . **Do not back vent cap all the way out!**
- Allow oil to vent approximately 30 seconds or until an air free stream of oil comes from each vent screw.

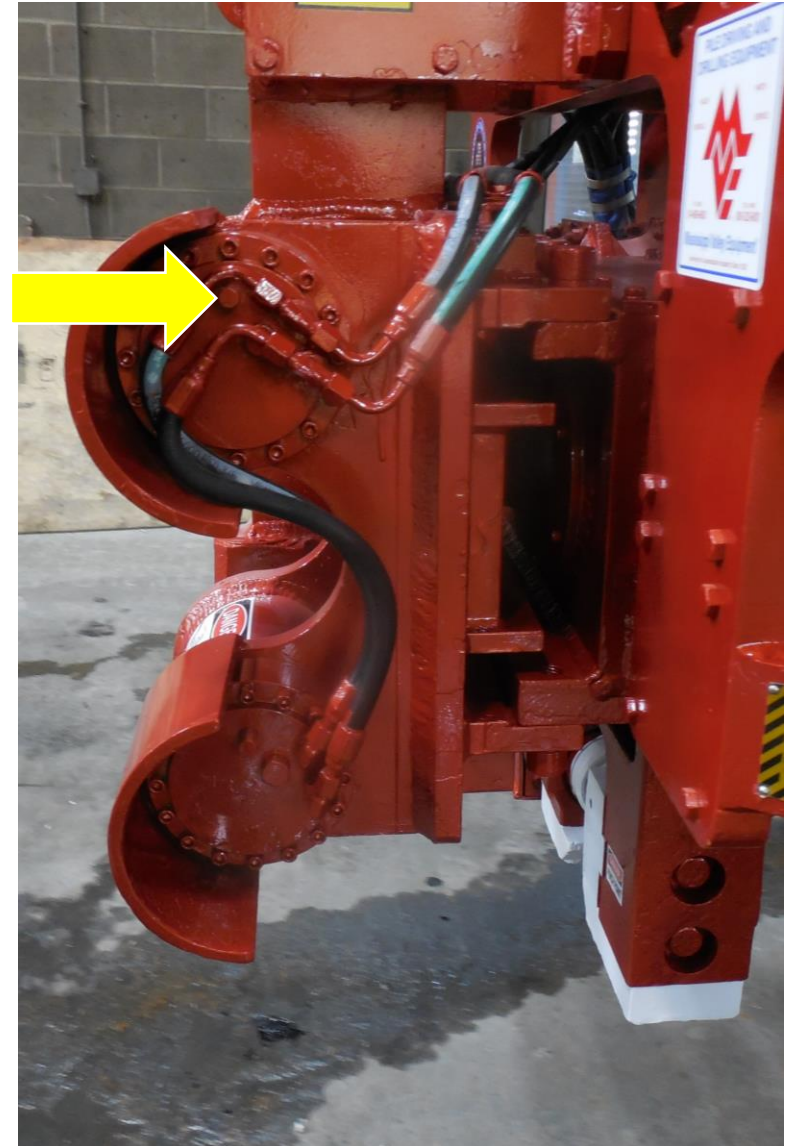

SETTING THE CYCLES OF THE MKT V-4Esc VIBRATORY HAMMER

You will need a photo-tachometer like the one in the photo below



Hold the laser or light beam from the photo-Tachometer on the bottom edge of the exciter case while the vibratory hammer is vibrating



ADJUSTING CYCLES



WARNING

To make following adjustments safely you will need to adjust the flow control cartridge on the manifold labeled #8 with the MKT V-4Esc not vibrating.

- Turning the set screw in will slow down the vibratory hammer.
- Turning the set screw out will speed up the vibratory hammer.
- When you have made the necessary adjustments, start the vibratory hammer and check the cycles as explained in the previous slide.
- Repeat the above steps until you obtain a speed between 2225 to 2250 cycles.

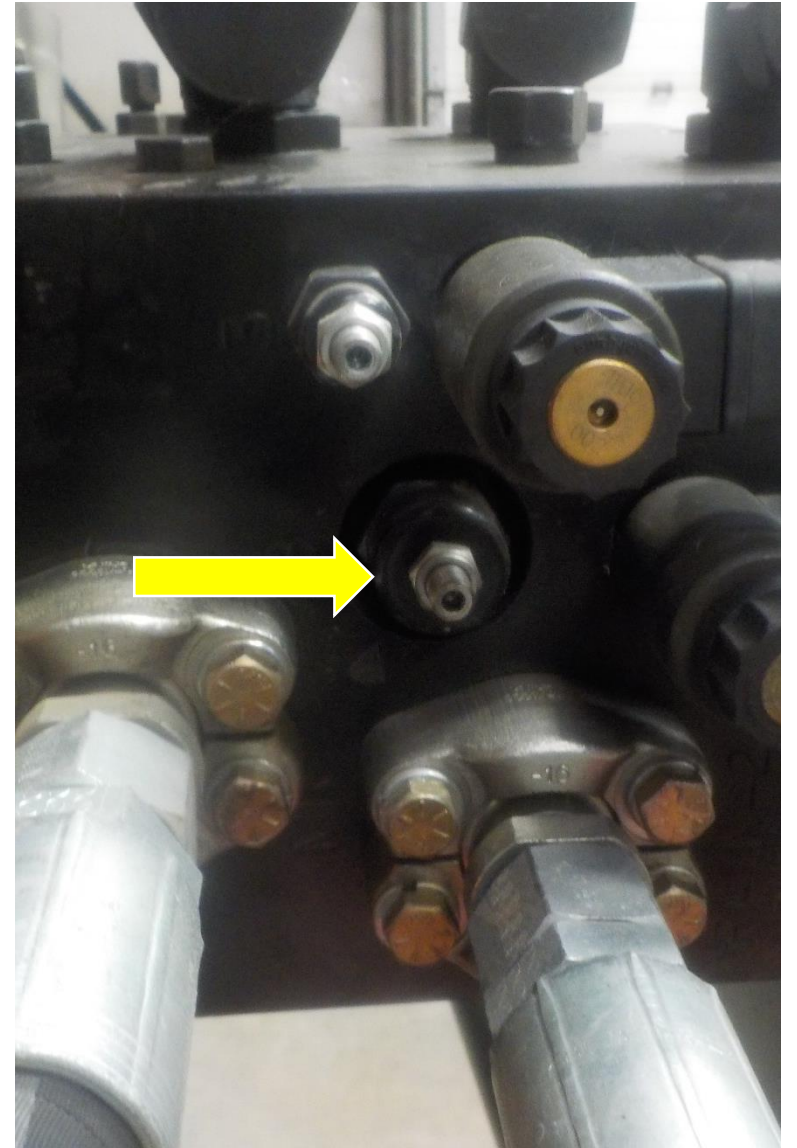

MKT V-4Esc OPERATING, MAINTENANCE AND SERVICE MANUAL



Prior to the use of this equipment everyone that will be or will assist in the operation of this equipment must read and understand the MKT V-4Esc Operating, Maintenance and Service Manual. Failure to read and understand the MKT V-4Esc Operating, Maintenance and Service Manual will result in property damage, severe injury or death.

INSTALLATION IS COMPLETE

You are now ready to put the MKT V-4Esc vibratory hammer to work. Please click the link to view an animation of the MKT V-8Esc in action <https://www.youtube.com/watch?v=nt2KZI4YErk>

. If you have any questions please click on www.mktpileman.com for your nearest MKT representative